



THE GENERAL RADIO

Experimenter

AN ELECTRONIC

MULTIFILTER

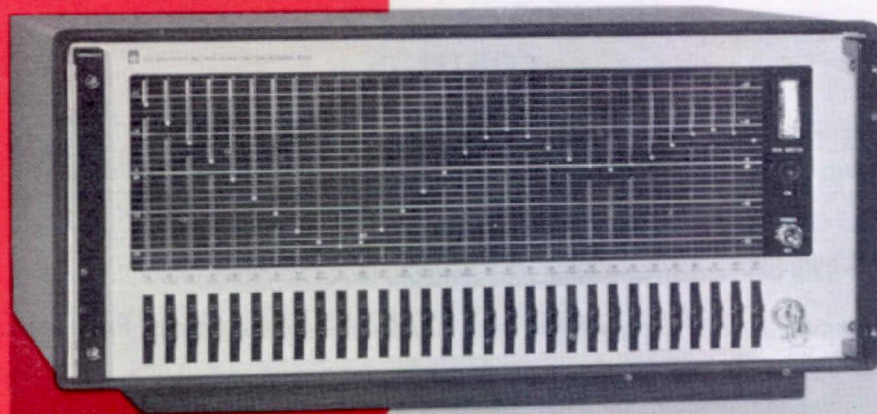

ALSO IN THIS ISSUE:

- HIGH DEGREE OF FREQUENCY RESOLUTION WITH A SYNCABLE OSCILLATOR
- 100:1 SCALER
- REDESIGNED TONE-BURST GENERATOR

VOLUME 42 · NUMBER 10 / OCTOBER 1968

CONTENTS

	Page
High Degree of Frequency Resolution Achieved through Use of Syncable Oscillator in Closed Loop	3
A Calibrated Spectrum Synthesizer	5
A 100:1 Scaler for Frequency Measurements to 500 MHz	11
Redesigned Tone-Burst Generator has Customer-Suggested Features	14

the  Experimenter

Volume 42 • No. 10 October 1968

Published monthly by the General Radio Company

© 1968 — General Radio Company, West Concord, Mass., USA

The *General Radio Experimenter* is mailed each month without charge to engineers, scientists, technicians, educators, and others interested in the instruments and techniques of electrical and electronics measurements. Address all correspondence to Editor, *General Radio Experimenter*, General Radio Co., West Concord, Mass. 01781.

HIGH DEGREE OF FREQUENCY RESOLUTION ACHIEVED THROUGH USE OF SYNCABLE OSCILLATOR IN CLOSED LOOP

When Dr. P. E. Armstrong of the Los Alamos Scientific Laboratory wanted to explore the high-Q mechanical resonances of clamped samples of magnetic alloys, he achieved the needed frequency stability and resolution not with a frequency synthesizer but with

one of GR's inexpensive "syncable" oscillators.

The experimental setup is shown in Figure 1. Vibrations are excited in the rod by a nearby coil driven through an amplifier by the TYPE 1310 Oscillator. The rod is slightly magnetized by an

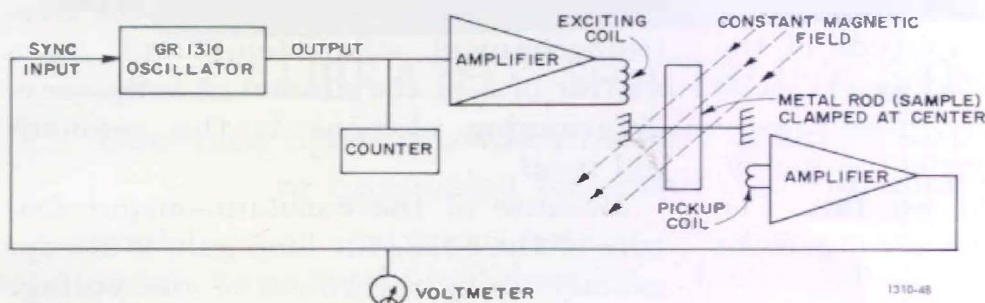

Figure 1. Block diagram of the experimental setup used by Dr. Armstrong to investigate the mechanical resonance of the clamped-magnetic rod.

WINNER OF GR'S "THINK SYNC" CONTEST



GR District Manager Frank Thoma (left) and Sales Engineer Dave McGreenery (right) present 1312 Decade Oscillator to Dr. Armstrong.

At the New York IEEE Show this year, General Radio announced a technical contest to discover novel applications of the synchronizing capability of GR's low-frequency oscilla-

tor line. The prize was choice of any of the five "syncable" oscillators.

We were impressed by the ingenuity with which many of the contestants exploited some not-altogether elementary aspects of the sync capability, and from our point of view the contest was an edifying success. The criteria for selection of a winner were originality and usefulness of the application. It was the final decision of our judges to award the prize to Dr. P. E. Armstrong, Los Alamos Scientific Laboratory, Los Alamos, New Mexico, whose application is described in the accompanying article. Our congratulations to Dr. Armstrong, who chose the Type 1312 Decade Oscillator as his prize.

Peter A. Previte received his BSEE degree in 1966 from Northeastern University. After graduation he joined General Radio's Sales-Promotion Department, where he is a product-line specialist for low-frequency oscillators. He is a member of Eta Kappa Nu.



externally applied constant magnetic field and therefore induces in the pick-up coil a signal that, in frequency, phase, and amplitude, is a faithful replica of the mechanical oscillation of the rod. The relative amplitude of the rod's vibration is indicated by the voltmeter, while the counter gives a very precise reading of the driving frequency.

Quite straightforward so far. The remarkable feature of the arrangement

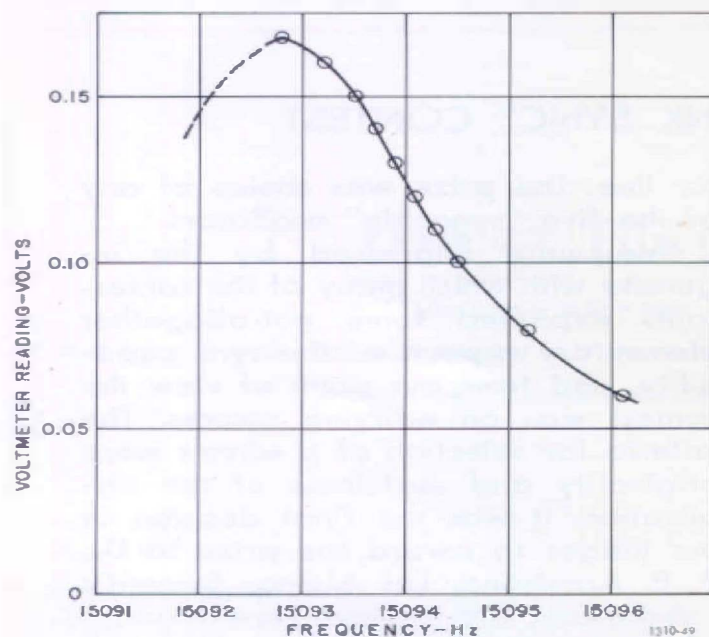

Figure 2. Plot of resonance data for a typical sample. The system turned out to be unstable below resonance, but data for this region could have been obtained, if necessary, by reversing connections somewhere in the loop.

is immediately apparent from a glance at some typical resonance data shown in Figure 2. The bandwidth of the resonance is a few hertz at about 15 kHz. One does not expect to be able to achieve this kind of resolution with a general-purpose laboratory oscillator! The trick is closing the loop through the oscillator's synchronizing jack.

Of course, in the absence of synchronization, the frequency at which the rod is driven would be determined simply by the setting of the 1310's frequency dial. But the oscillation frequency of the closed-loop system depends upon both the 1310 and the electromechanical subsystem, and as a matter of fact the dominant frequency-determining element is the resonant rod itself.

Because of the constant-output feature of the 1310, the loop gain is always exactly unity regardless of the voltage at the synchronizing jack. The system therefore oscillates at a frequency for which the total phase shift around the loop is zero. Now, the locked 1310 is effectively a variable phase shifter. With a sufficient voltage at the synchronizing jack, the phase shift through the 1310 changes only gradually with frequency and with the setting of the frequency dial. On the other hand the phase shift through the high-Q electromechanical part of the system changes very abruptly with frequency in the vicinity of the mechanical resonance. Thus the frequency of oscillation, which is determined by the zero-phase condition, is predominantly under the control of the clamped rod; the 1310's frequency dial serves as a frequency vernier.

— P. A. PREVITE

The new Type 1925 Multifilter. The model shown here covers the frequency range from 25 Hz to 20 kHz in 1/3-octave bands.

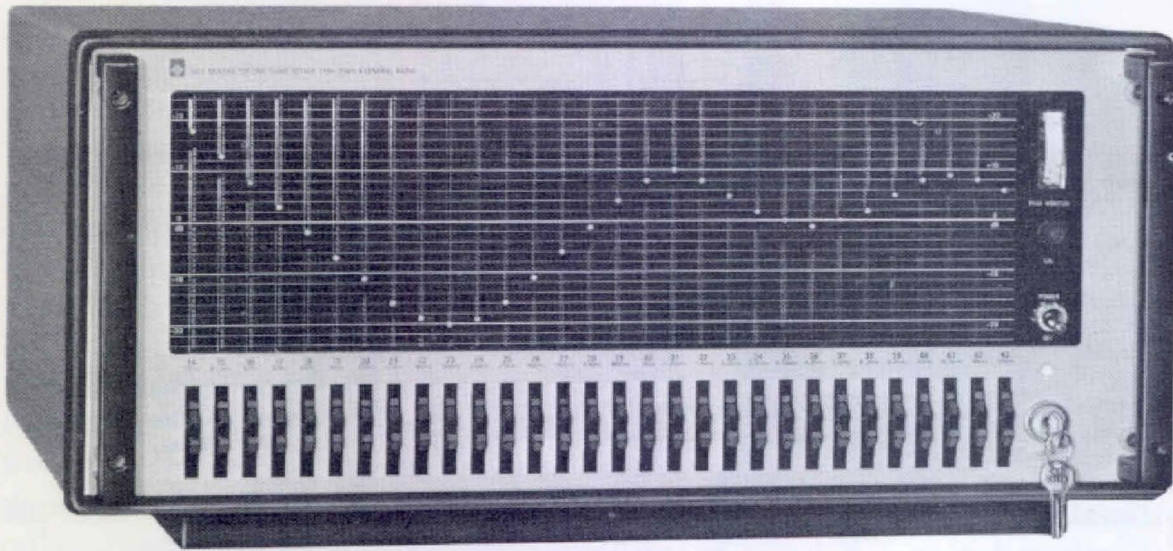

A CALIBRATED SPECTRUM SYNTHESIZER

Electronic filters provide precisely calibrated spectrum shaping or equalizing for sound and vibration work

A parallel set of contiguous octave-band or 1/3-octave-band filter channels, each including an adjustable attenuator — such a system, the basis for a number of spectrum-synthesis and spectrum-analysis techniques, is embodied in GR's new 1925 Multifilter.

The multifilter normally includes 30 filters and 30 calibrated, 1-dB-per-step attenuators, although it can be supplied with more or fewer channels, and the attenuators are optional. The octave- and 1/3-octave-filter characteristics (Figure 1) conform to both American

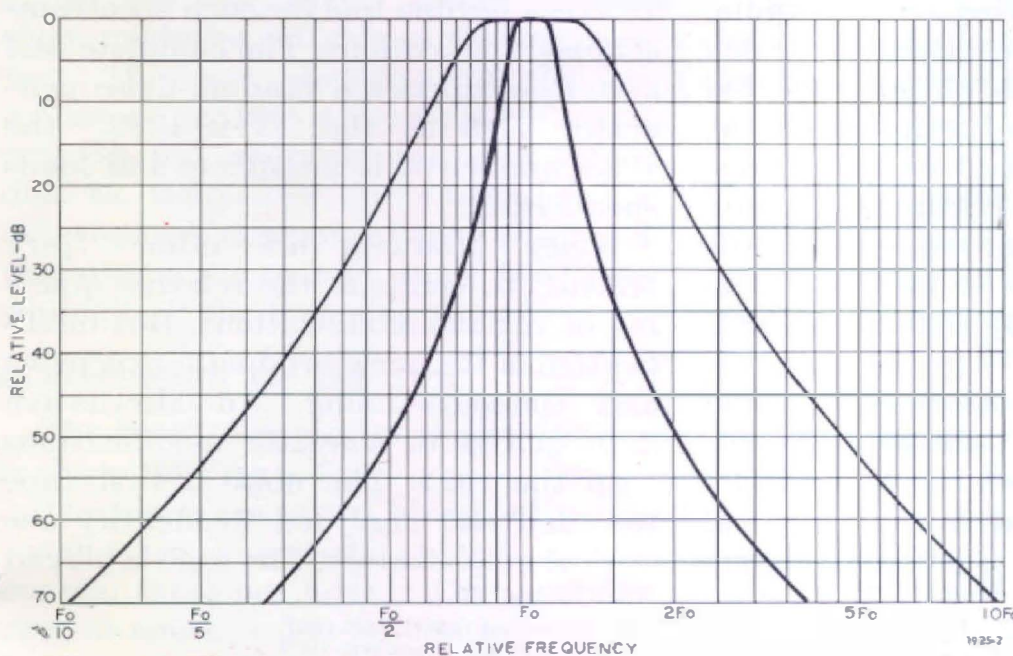

Figure 1. Octave and 1/3-octave filter characteristics.

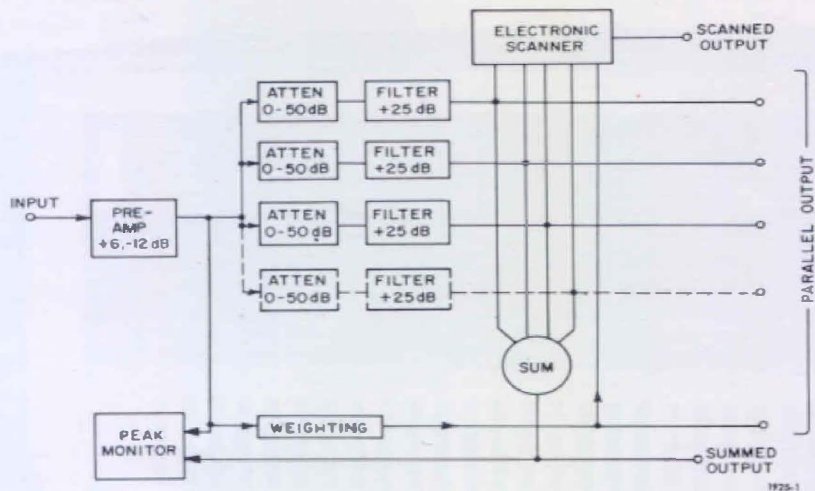

Figure 2. Block diagram of the multi-filter.

and international standards. Both meet the IEC Recommendation Publication 225-1966; the third-octave characteristic meets the USA Standard S1.11-1966 Class III (high attenuation); the octave characteristic meets the same standard, Class II (moderate rate — highest for octave-band filters). Channel frequencies from 3.15 Hz to 80 kHz are available in standard models of the instrument.

The outputs from the filter channels are accessible in three different ways: 1) simultaneously at separate outputs, 2) summed at a single output, or 3) one at a time at a single output, selected either by push-button switches on the rear panel, by external switch closures, or by a GR TYPE 1771 Scanner Control. The 1771 allows either sequential scanning of the channels or random selection by BCD (1-2-4-8) coded standard¹ band numbers.

The channel attenuators are adjusted by thumbwheels in 1-dB steps over a 50-dB range. The setting of each attenuator is indicated by the vertical position of a dot that is part of a unique front-panel display — the dot pattern that appears on the front panel creates

a graph of the instrument's over-all transmission characteristic. This graphic display has a vertical scale factor of 10 dB per inch and a horizontal frequency scale factor of 5 inches per decade, matching recorder chart paper commonly used in sound and vibration work.

APPLICATIONS

High-level-sound tests on such structures as airframes are carried out with especially shaped noise spectra. The 1925 is a flexible tool for such spectrum-shaping applications. The complete test system comprises a random-noise generator such as the TYPE 1382,² the 1925, and suitable amplifiers and loudspeakers.

Noisy products are often "jury tested" to compare the relative quieting of various modifications. But modification of the noisy product is expensive and time-consuming. An alternative approach is to simulate modifications with the 1925. The noise is first tape recorded and analyzed to identify the critical noise sources. The tape is played

¹USA Standard (ASA) S1.6-1967.
²GR *Experimenter*, January, 1968.

back through the multifilter, which permits selective control over the amplitudes of individual noise components, and a listening jury is asked to rate the modified noise.

The 1925 can be used to simulate the transmission characteristics of walls, partitions, and other acoustic systems, thus saving the cost of constructing the barrier in order to test its effectiveness.

In broadcast- and recording-industry applications, the 1925 permits unusually flexible and precise control over recording and playback equalization, program-line equalization, and pre- and de-emphasis. As a filter, the 1925 not only offers greater versatility than passive filters or even tunable electronic filters, it also provides a calibrated display of its frequency characteristic.

With accessory equipment, the multifilter becomes a parallel or serial spectrum analyzer. Channels can be selected in sequence with a TYPE 1771 Scanner Control, or the parallel outputs of the 1925 can be used to drive a set of detectors and recorders. The adjustable attenuators are in principle unnecessary in the analyzer, and a model without them might be suitable in this application. However, inclusion of the attenuators makes it possible to compensate for frequency-response errors due to transducer, tape-recorder, or other system components and to extend the system's dynamic range by "pre-whitening" the incoming signal.

COMPONENTS OF THE 1925

The block diagram of the multifilter is shown in Figure 2.

The filters are active, six-pole Butterworth types, mounted on plug-in etched boards, three per board. This modular plug-in construction results in a great

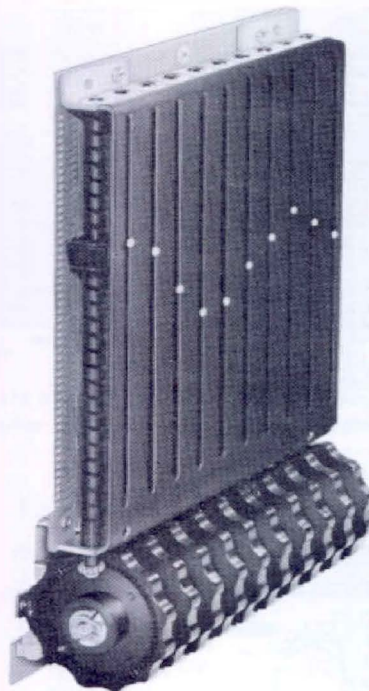

Figure 3. An assembly of ten of the adjustable attenuators. The setting of each attenuator is indicated by the vertical position of a dot in the front-panel display.

deal of flexibility, allowing both easy conversion of a standard model of the instrument from one frequency range to another and straightforward assembly of special versions. Models with non-standard frequency ranges, with mixtures of octave and $\frac{1}{3}$ -octave channels, or even with special-bandwidth channels can be assembled on special order.

The channel attenuators are etched-circuit switches and integrated resistor circuits. An attenuator assembly, shown in Figure 3, has a single input and ten outputs to drive a block of ten filter channels. Three of these assemblies are used in a standard $\frac{1}{3}$ -octave-band version of the multifilter, and one is used in an octave-band version. The main chassis is built to house up to three attenuator assemblies, thirty filters, and input, output, and power-supply circuitry. Reed relays switch the output of each filter channel to an output connector.

Four additional channels, one each with standard A-, B-, and C-weighting

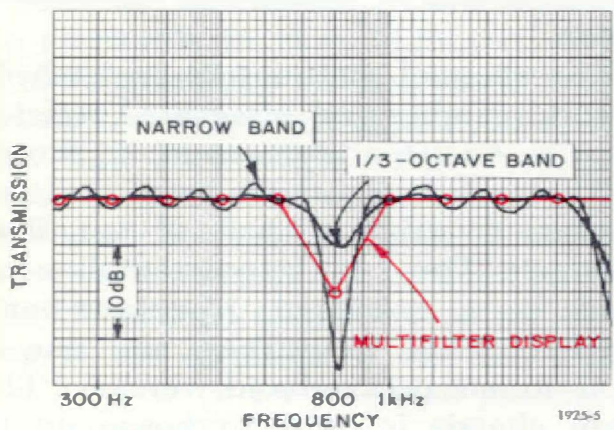
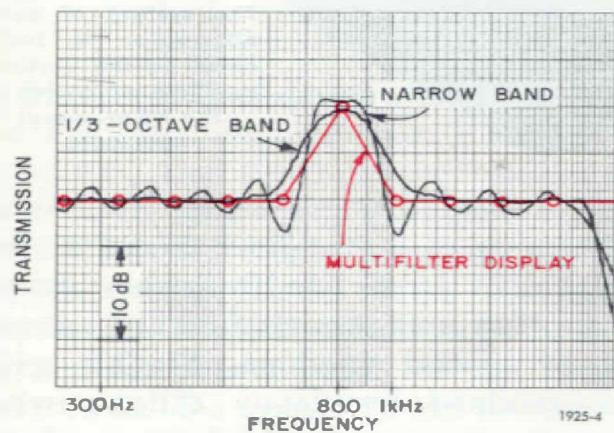
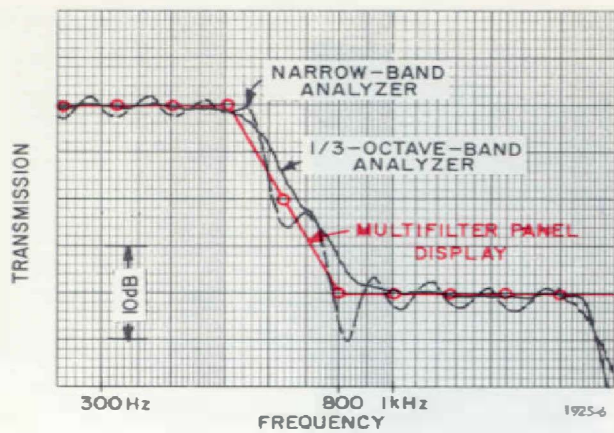

Figure 4. The multifilter's display is generally a better indication of the synthesized spectrum than one can get from a 1/3-octave analysis. Shown here are three awkward spectra. The red circles represent the dots on the front-panel display; the dashed black line is the "true" (narrow-band) spectrum. Notice that the fine-structure in the true spectrum does not appear in the 1/3-octave analysis (solid black line).

networks and one with flat response, are accessible at their own output connectors and can be scanned along with the filter channels. Peak detectors, before and after the filter channels, monitor for overload, and their outputs are displayed by a panel meter calibrated in dB referred to the overload level. Current proportional to the meter deflection is available at a rear-panel connector.

A WORKING MEASURE OF THE SYNTHESIZED SPECTRUM SHAPE

The remarkable versatility of the 1925 has been achieved by dividing up the frequency spectrum into contiguous bands. When one is using the 1925 for spectrum shaping, it is important to bear in mind the particular characteristics and limitations inherent in this method of spectrum shaping.

First, we cannot synthesize detail that is finer than the bandpass characteristic of the individual channels. Suppose we try to generate a narrow band of noise by attenuating all but one 1/3-octave multifilter channel. The spectrum we shall generate is a band of energy 1/3 octave wide — a narrower peak is unattainable with 1/3-octave filters. If we try to generate a dip in the spectrum by attenuating only one channel, we encounter the effect of finite stop-band-attenuation rates. Even though the filters have extremely high attenuation rates, the adjacent channels will partially fill-in for the attenuated channel and thereby limit the attenuation in the notch.

Second, because of phase cancellations and reinforcements when the channel outputs are summed, the spectrum synthesized by the multifilter has a fine-structure of narrow peaks and

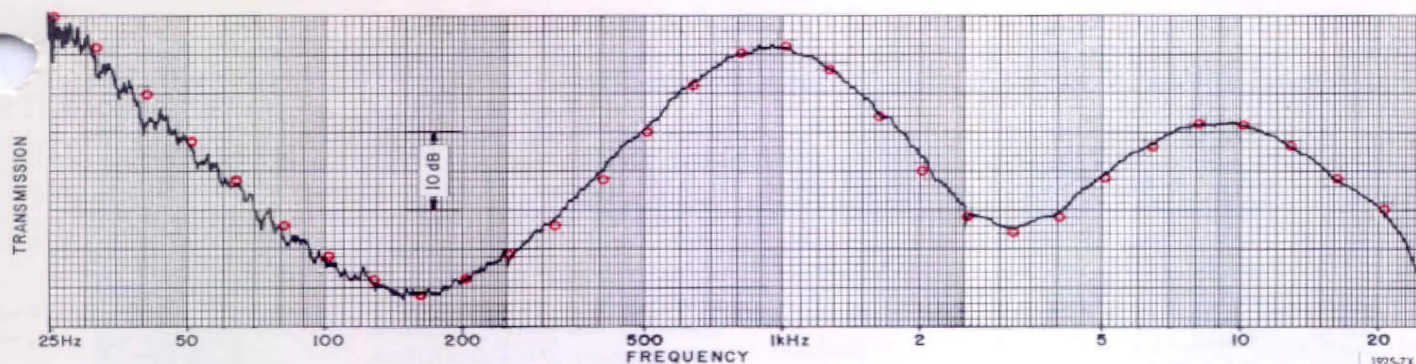

Figure 5. A more likely example. When there are no abrupt discontinuities or steep slopes, the $\frac{1}{3}$ -octave analysis (solid black line) departs from the multifilter display by less than the measurement error.

dips. The widths of individual features in the fine-structure are always much less than the channel bandwidth, and the spectrum, viewed through a "window" that is as wide as or wider than the channel bandwidth, is a smooth curve that conforms to the dot pattern on the front-panel display.

A parallel can be drawn between the accuracy of a spectrum synthesizer in shaping a spectrum and the accuracy of an analyzer in resolving one. A discrete frequency component, swept by a $\frac{1}{3}$ -octave-band analyzer, looks like a band of energy $\frac{1}{3}$ -octave wide. When we use the $\frac{1}{3}$ -octave analyzer to look at a spectrum with an unusually narrow dip, the $\frac{1}{3}$ -octave bandwidth and finite stop-band-attenuation rate cause the dip to fill in. When we analyze a spectrum having peaks and valleys narrower than the bandwidth of the analyzer, we get an averaged, smooth curve in which the peaks and valleys do not appear.

One might feel that an analyzer with narrower bandwidth should be used for these measurements; if it is necessary to see fine detail in the spectrum, then, indeed, a narrow-band analyzer must be used. But for most purposes a $\frac{1}{3}$ -octave analysis is entirely satisfactory. Users of sound analyzers understand and accept the limitations

that bandwidth imposes on resolution, and the effects of finite resolution are readily interpreted by those experienced in the art.

Now, these same considerations apply to the spectrum synthesizer. Just as we must use an analyzer with narrower bandwidth to look at finer detail in a spectrum, so must we use a set of narrower filters if the resolution of our synthesizer is insufficient for our purpose. Although the spectrum synthesized by a $\frac{1}{3}$ -octave (say) multifilter may be, strictly speaking, somewhat in error with respect to the instrument's front-panel display, a $\frac{1}{3}$ -octave analysis of the spectrum will also be in error, and usually to a greater degree. The situation is illustrated in Figures 4 and 5.

Conclusions: 1) It is helpful when using a spectrum synthesizer to bear in mind the analogy between synthesizers and analyzers. 2) The multifilter's $\frac{1}{3}$ -octave calibrated panel display gives a better measure of averaged spectrum shape than can be obtained from a $\frac{1}{3}$ -octave analysis. 3) If we are going to look at a spectrum with $\frac{1}{3}$ -octave resolution, there is no need to use greater than $\frac{1}{3}$ -octave resolution to synthesize it.

— W. R. KUNDERT

A brief biography of Mr. Kundert appeared in the April 1968 issue of the *Experimenter*.

SPECIFICATIONS

FILTERS

Characteristics: (Figure 1) Both octave-band and one-third octave-band filters are six-pole Butterworth designs. Specified bandwidths are effective bandwidths, i.e., bandwidths for noise. Filters meet all current American and international standards: $\frac{1}{3}$ -octave conforms to USAS 1.11-1966 Class III (high attenuation), the octave filters to USAS 1.11-1966 Class II (moderate rate but highest for octave-band filters). Both octave and third-octave characteristics conform to IEC Recommendation Publication 225-1966.

Accuracy of Center Frequency: $\pm 2\%$.

Passband Ripple: 0.5 dB max peak to peak.

Uniformity of Levels: At center frequencies (attenuator at +25 dB) ± 0.25 dB at 25°C; ± 0.5 dB, 0 to 50°C.

Noise: $< 15\mu\text{V}$ equivalent input noise.

Distortion: For bands centered at 25 Hz and above, harmonic distortion at band center is $< 0.1\%$ at 1V out. For bands with center frequency below 25 Hz, distortion at band center is $< 0.25\%$ at 1V out.

ATTENUATORS

Range: Gain in each channel adjustable in 1-dB steps from +25 dB to -25 dB relative to nominal 0-dB gain by means of panel control.

Accuracy: ± 0.25 dB relative to +25-dB attenuation setting.

Readout: Panel display indicates attenuation in each channel and represents transmission between input and summed output. Display has standard 50-dB-per-decade scale factor; 10 dB per inch vertical, 5 inches per decade horizontal. Lock on panel prevents accidental changes in attenuator settings.

CHASSIS (accepts up to 30 filters)

Over-all Gain: 0 dB nominal.

Gain Adjustment: +6 to -12 dB, common to all channels.

Input Impedance: 100 k Ω .

Input Voltage: Ac component, ± 17 V pk max referred to dc component of input. Dc component, ± 35 V max.

Scanner: Any single filter output is selected by a rear-panel pushbutton, external switch closure, or by use of a Type 1771 Scanner

Control (available on special order), which displays and outputs (BCD) the channel number.

Peak Monitor: A peak detector senses levels at two circuit points and drives a panel meter calibrated in dB referred to overload level. A signal proportional to meter indication is available at an output jack for driving a dc recorder; 1 mA corresponds to full-scale reading.

OUTPUTS

Channel Outputs (Parallel Output)

Impedance: 20 Ω nominal.

Voltage: ± 4.2 V max (3 V rms sine wave).

Load Impedance: 3 k Ω minimum for max output voltage.

Scanned Output:

Impedance: 20 Ω nominal.

Voltage: ± 4.2 V max (3 rms sine wave).

Load Impedance: 3 k Ω minimum for max output voltage. Two chassis can be wired in parallel for up to 60 scanned channels.

Summed Output (For equalizing and shaping applications)

Impedance: 600 Ω .

Voltage: ± 4.2 V max, open circuit.

Load Impedance: Any. Will not affect linear operation of output.

Weighted and Unfiltered Outputs

Impedance: 20 Ω nominal.

Load Impedance: 3 k Ω minimum for max output voltage.

Gain: 0 dB nominal at 1 kHz.

Weighting: A, B, and C characteristics conform to requirements of current American and international standards including USAS 1.4, IEC R123, and IEC R179.

GENERAL

Accessories Supplied: Power cord, 36-terminal plugs (2), spare fuses, *Handbook of Noise Measurement*.

Power Required: 100-125 V or 200-250 V, 50-60 Hz, 17 W.

Mounting: Rack-bench mount.

Dimensions (width X height X depth): Bench, 19 $\frac{3}{4}$ x 9 $\frac{1}{8}$ x 14 in. (500 x 235 x 355 mm); rack, 19 x 8 $\frac{3}{4}$ x 12 $\frac{1}{4}$ in. (485 x 225 x 315 mm).

Weight: Net, 48 lb (22 kg), approx.

Catalog Number				Description	Price in USA	
With Attenuator		Without Attenuator			With Attenuator	Without Attenuator
Bench	Rack	Bench	Rack			
				1925 Multifilter		
				One-Third-Octave Bands		
1925-9700	1925-9701	1925-9712	1925-9713	25 Hz to 20 kHz	\$3500.00	\$3150.00
1925-9702	1925-9703	1925-9714	1925-9715	12.5 Hz to 10 kHz	3580.00	3230.00
1925-9704	1925-9705	1925-9716	1925-9717	3.15 Hz to 2.5 kHz	3680.00	3330.00
1925-9706	1925-9707	1925-9718	1925-9719	100 Hz to 80 kHz	3450.00	3100.00
				Octave Bands		
1925-9708	1925-9709	1925-9720	1925-9721	31.5 Hz to 16 kHz	2110.00	1990.00
1925-9710	1925-9711	1925-9722	1925-9723	4 Hz to 2 kHz	2210.00	2090.00

Note: Rack and bench versions of any model are priced the same.



Figure 1. The 1191-Z 500-MHz Counter.

A 100:1 SCALER FOR FREQUENCY MEASUREMENTS TO 500 MHz

The instrument shown in Figure 1 is the 1191-Z 500-MHz Counter, a combination of the already-popular 1191 Counter and the new 1157 Scaler. The present article discusses the scaler, an instrument that performs a relatively simple task: it accepts an input signal with a frequency up to 500 MHz and provides an output square wave whose frequency is exactly 100 times lower. The 1157, like its companion, the 1156-A Decade Scaler¹, is usable alone for any application where precise frequency division is required, or in combination with the 1191 Counter² or the recently-announced 1159 Recipro-matic Counter³.

APPLICATIONS

Counter Range Extension

Scalers (or prescalers) provide a simple and economical means for extending the frequency ranges of counters. The one drawback is a loss of resolution when they are used with low-frequency counters. With high-fre-

quency counters, however, such as the 1191 or the 1159, this drawback disappears. With an 1191-Z combination one can measure 500 MHz with a resolution of 2 parts in 10^7 for a 1-second measurement and 2 parts in 10^8 for a 10-second measurement.

When the TYPE 1157 Scaler is used to extend the frequency range of a counter, the frequency to be measured is applied to the input of the Scaler, and the output of the Scaler is applied to the input of the counter. The Scaler output signal is sufficient to drive any known counter over the Scaler's entire range. The frequency is read from the counter by moving the decimal point in the counter display two places to the right (multiplication by 100). The accuracy of the measurement is not affected by the Scaler. Accuracy is strictly a function of the counter and is usually specified as ± 1 count (at counter input) \pm crystal-oscillator stability.

¹ *GR Experimenter*, September 1965.

² *GR Experimenter*, December 1967.

³ *GR Experimenter*, June 1968.

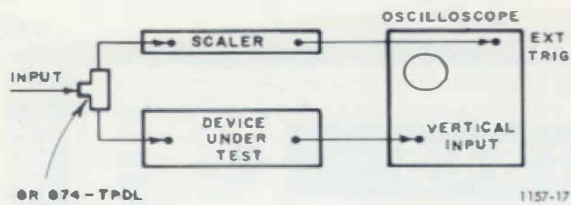

Figure 2. Use of the 1157 Scaler to trigger an Oscilloscope.

FM Measurements

The scaler is a wide-band frequency divider using digital pulse-count techniques and is not restricted to narrow-band sinusoidal signals. Frequency-modulation characteristics of the input signal are therefore preserved (divided by 100) and the scaler can be used to extend the range of frequency discriminators. For example, the 1157 Scaler can be used with the 1142-A Frequency Meter and Discriminator to extend its range to 150 MHz. An 1156-A Decade Scaler connected between the 1157 and 1142-A can extend the range further to 500 MHz.

Oscilloscope Trigger

The TYPE 1157 Scaler is especially valuable in the trigger path of an oscilloscope whose trigger capabilities are inadequate to lock a signal within its vertical passband. This technique is equally useful in testing scalars or frequency dividers even at lower frequencies. If the trigger is taken from the output of the device under test

and the output waveform changes or the device fails, the trigger is lost. But if the trigger is taken ahead of the device (see Figure 2), the trigger is independent of the device. This is also an advantage when making time-relationship measurements comparing several points in the device, since the output from the 1157 Scaler can be used as a time reference.

DESCRIPTION

The 1157 Scaler is housed in a 3 1/2-inch-high relay-rack or bench cabinet. Input and output connectors are GR874® locking connectors, which can be conveniently moved to the rear of the instrument for racked-systems applications.

An input-attenuator control and level meter are provided on the panel for convenient adjustment of the input-signal level. The input impedance is 50 ohms for all positions of the attenuator control. Thus the scaler can be used as a 50-ohm load or cable termination. Alternately 50-ohm oscilloscope probes such as the Tektronix P6026, P6034, and P6035 can be used to raise the input impedance.

The input sensitivity is specified as 0.1 volt rms to 500 MHz. Figure 3 shows the sensitivity of a typical instrument as a function of frequency for a sine-wave input.

Figure 3. Typical and specified peak-to-peak sine-wave input voltage required to drive the 1157 Scaler.

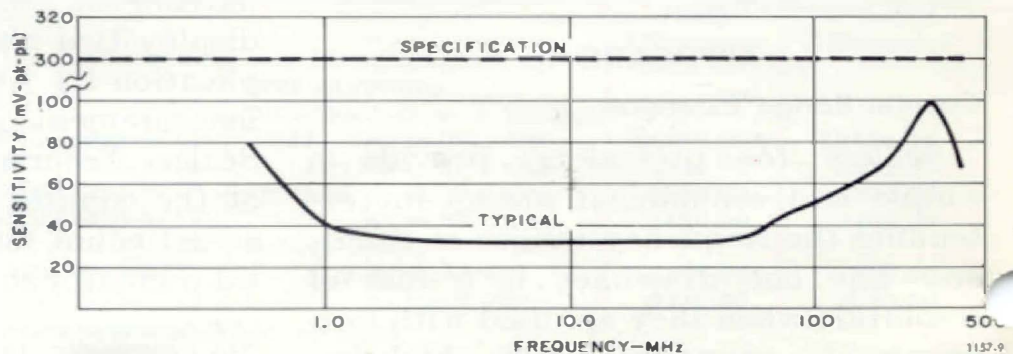

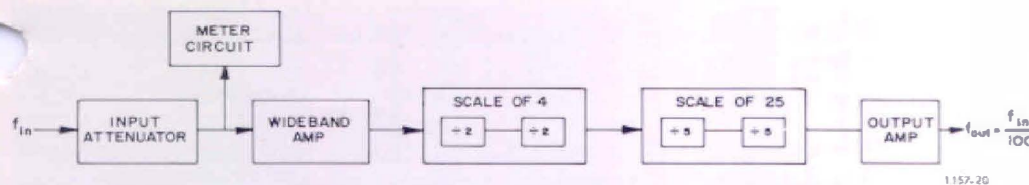

Figure 4. Simplified block diagram of the 1157 Scaler.

HOW IT WORKS

Block Diagram

Figure 4 shows a simplified block diagram of the 1157 Scaler. The instrument contains a 50-ohm attenuator, an input metering circuit, a wide-band amplifier, a scale-of-4 divider (2 cascaded flip flops), a scale-of-25 divider (2 cascaded divide-by-5 circuits), and an output amplifier. Interesting features of the circuits are discussed below.

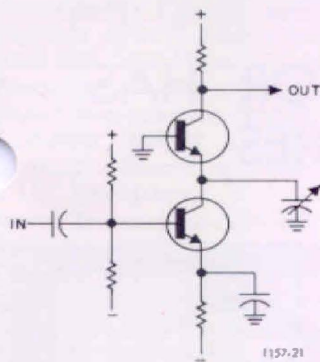

Figure 5. Simplified schematic diagram of the emitter-peaked cascode amplifier.

Input Amplifier

In this amplifier we reinvented the cascode circuit, but with a new twist.⁴ Figure 5 shows a simplified schematic diagram of one stage of the amplifier. The small trimmer capacitor connected from the collector of the lower (common-emitter) transistor to ground combines with the inductive input impedance of the upper (common-base) transistor to form a low-Q resonant circuit. This trick extends the frequency response of an ordinary cascode circuit from 200 MHz, or so, to over 500 MHz. Two such stages interconnected by a

⁴H. T. McAleer, "Emitter Peaking Pushes Bandwidth to 500 MHz," *Electronics*, Sept 4, 1967.

shunt peaking network are used in the amplifier.

Scale-of-4 Divider

Figure 6 shows a simplified schematic diagram of one of the two flip-flops in the divider. The circuit uses a high-speed tunnel diode in combination with a transistor differentiating circuit to produce a nanosecond pulse which operates the following tunnel-diode circuit as a complemented flip-flop. This simple flip-flop circuit⁵ has proved very useful in both low- and high-frequency divider applications.

Scale-of-25 Divider

The scale-of-25 divider uses two cascaded "Englemann Rings"⁶, a unique combination of 5 bi-stable Schmitt circuits serially connected to form a ring counter.

Output Amplifier

The output amplifier includes a Schmitt circuit and provides sharp square waves of about 7 volts peak-to-

⁵W. F. Chow, "Tunnel-Diode Digital Circuitry," *IRE Transactions on Electronic Computers*, EC-9(3), 295-301, Sept 1960.

⁶Rudolph Englemann, "Bi-quinary Scaling: Accuracy and Simplicity at 500 Mc," *Electronics*, p 34, November 15, 1963.

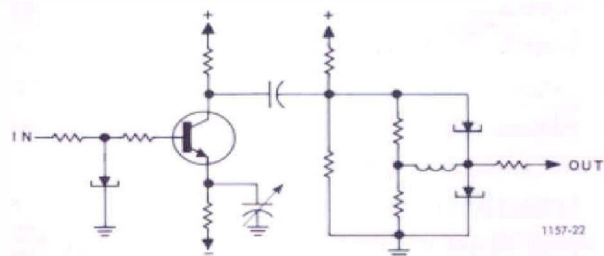

Figure 6. High-speed flip-flop — simplified schematic diagram.

peak amplitude (open circuit). The amplifier can deliver 20 mA into a low impedance and thus can supply 1 volt peak-to-peak to a 50-ohm load.

— H. T. McALEER

A brief biography of Mr. McAleer appeared in the December 1966 issue of the *Experimenter*.

ACKNOWLEDGMENTS

Early design of the 1157 Scaler was done by H. T. McAleer. J. K. Skilling and R. L. Moynihan assisted in the latter stages of development.

SPECIFICATIONS

INPUT

Frequency: 1 to 500 MHz.
Sensitivity: Better than 0.3 V pk-pk (0.1 V rms) over entire range.
Impedance: 50Ω.
Attenuator: 1-2-5 sequence for signals up to 5 V rms.
Max Input: 5 V rms.

OUTPUT

Frequency: 0.01 to 5 MHz. Approx square-wave output, 20 mA pk-pk; > 5 V pk-pk open-circuit, 1 V pk-pk into 50Ω.
Impedance: 250Ω.

GENERAL

Power Required: 105 to 125 or 210 to 250 V, 50 to 60 Hz, 25 W.

Terminals: GR874® locking connectors; can be attached to either front or rear panel. Adaptors to other connector types available.

Catalog Number	Description	Price in USA
1157-9801	1157 Scaler 100:1 Bench Model	\$650.00
1157-9811	Rack Model	650.00
1191-9900	1191-Z Counter (100 MHz) Bench Model	2040.00
1191-9901	Rack Model	2040.00
1191-9902	1191-Z Counter (500 MHz) Bench Model	2190.00
1191-9903	Rack Model	2190.00

REDESIGNED TONE-BURST GENERATOR HAS CUSTOMER-SUGGESTED FEATURES

Wider frequency range

Increased suppression of signal during off period

More output

Timed or counted intervals may be selected independently for both on and off periods

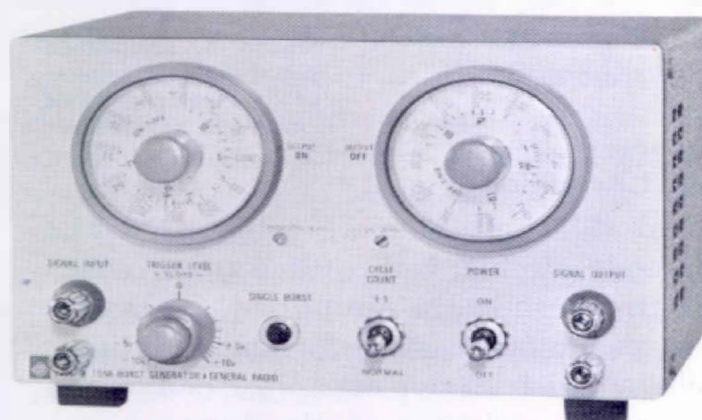

When the TYPE 1396-A Tone-Burst Generator was first introduced early in 1964 it promptly created a name for itself in sonar, audio, acoustics, psychoacoustics, electroacoustics, and other fields where the measurement of ac transient response to bursts of coherent sine waves is a powerful testing technique.¹ The considerable number of unforeseen uses to which the 1396-A was

put prompted a redesign, which incorporates features that enhance the instrument's usefulness in many applications.

Among the new features that have been built into the 1396-B is the provision for independent choices of either

¹J. K. Skilling, "A Generator of AC Transients," *GR Experimenter*, May, 1964; "Testing with Tone-burst Signals," *The Electronic Engineer*, December, 1966 (GR Reprint A130). ———, "The Frequency Spectrum of a Tone Burst," *GR Instrument Notes*, 1N-105.

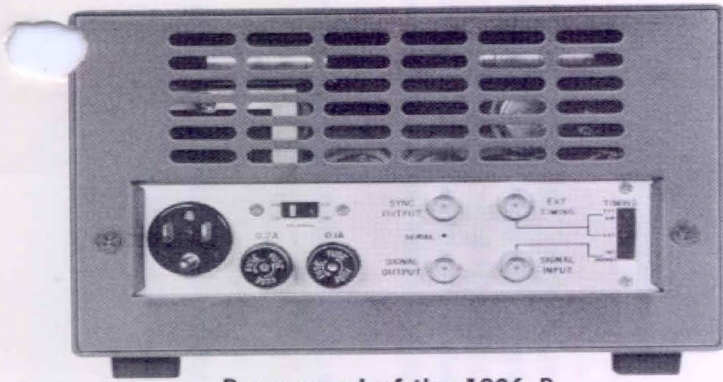

Rear panel of the 1396-B.

counted or timed intervals for both the on and off periods. This flexibility will be found useful in sonar and psychoacoustic applications, where a

long burst is often required. The addition of a single-burst button facilitates those applications in physiology and experimental psychology that require the generation of a single burst on the experimenter's command.

Here are some of the applications to which the tone-burst technique is uniquely suited: transducer testing in the presence of reflections, self-reciprocity transducer calibration, measurement of room acoustics, measurement of ac meter ballistics, recovery-from-overload tests, music-power measurements, generation of power-line transients.

SPECIFICATIONS

SIGNAL INPUT (signal to be switched)
Amplitude: Proper operation results from input signals of not greater than 10 V pk (7 V rms) and not less than 1 V pk-pk.
Frequency Range: Dc to 2 MHz.
Input Impedance: 50 kΩ, approx.
TIMING INPUT (signal that controls switching). Same specifications as SIGNAL INPUT except:
Input Impedance: 20 kΩ, approx.
SIGNAL OUTPUT
Output On: Replica of SIGNAL INPUT at approx same voltage level; dc coupled; down 3 dB at >1 MHz. Output current limits at >25 mA pk, decreasing to >15 mA at 2 MHz. Output source impedance typically 25 Ω increasing above 0.2 MHz. Total distortion contribution <0.3% at 1 kHz and 10 kHz.
Output Off: Input-to-output transfer (feed-through), <-60 dB, dc to 1 MHz, increasing above 1 MHz.
Spurious Outputs: Dc component and change in dc component due to on-off switching (pedestal) can be nulled with front-panel control. Output switching transients are typically 0.2 V pk-pk and 0.2 μs in duration (120-pF load).
ON-OFF TIMING: Timing is phase-coherent with, and controlled by, either the signal at the SIGNAL INPUT connector or a different signal applied to the EXT TIMING connector. The on interval (duration of burst) and the off interval (between bursts) can be determined by cycle counting, timing, or direct external control.
Cycle-Count Mode: On and off intervals can be set independently, to be of 1, 2, 4, 8, 16, 32, 64, or 128 cycles (i.e. periods) duration or to be 2, 3, 5, 9, 17, 33, 65, or 129 cycles with +1 switcherated.

Timed Mode: On and off intervals can be set, independently, for durations of 10 μs to 10 s. On and off times occur at first proper phase point of controlling signal occurring after time interval set on controls; one interval can be timed while other is counted.
Switching Phase: In above modes, input controls determine phase of timing signal at which on and off switching occurs. SLOPE control selects either positive or negative slope of timing signal: TRIGGER LEVEL control sets voltage level at which both on and off switching occur.
Direct External Control: A 10-V pulse applied to rear-panel connection will directly control switching.
SYNCHRONIZING PULSE: A dc-coupled pulse that alternates between approx +8 V for output on, and -8 V when off. Source resistance approx 0.8 kΩ for positive output and 2 kΩ for negative.
GENERAL
Power Required: 100 to 125 or 200 to 250 V, 50 to 400 Hz, 16 W.
Accessories Supplied: Power cord.
Mounting: Convertible-Bench Cabinet.
Dimensions (width × height × depth): Bench, 8½ × 5⅝ × 10¼ in. (220 × 145 × 260 mm); rack, 8½ × 5¼ × 8⅝ in. (220 × 135 × 255 mm).
Weight: Net, 8 lb (3.7 kg); shipping, 12 lb (5.5 kg).

Catalog Number	Description	Price in USA
	1396-B Tone-Burst Generator	
1396-9702	Bench Model	\$550.00
1396-9703	Rack Model	\$72.00

GENERAL RADIO COMPANY

WEST CONCORD, MASSACHUSETTS 01781
617 369-4400

SALES AND SERVICE

Area	Telephone
Albuquerque	505 255-0611
Atlanta	404 633-6183
*Boston	617 646-0550
Bridgeport	203 377-0165
*Chicago	312 992-0800
Cleveland	216 886-0150
Cocoa Beach	800 241-5122
*Dallas	214 ME7-2240
Dayton	513 434-6979
Denver	303 447-9225
Detroit	313 261-1750
Houston	713 622-7007
Huntsville	800 241-5122
Indianapolis	317 636-3907
*Los Angeles	213 469-6201
Montreal	514 737-3673
New Haven	203 377-0165
*New York	(NY) 212 964-2722 (NJ) 201 943-3140
Ottawa	613 233-4237
Philadelphia	215 646-8030
San Diego	714 232-2727
San Francisco	415 948-8233
Seattle	206 GL4-7545
Syracuse	315 454-9323
*Toronto	416 247-2171
*Washington/Baltimore	301 946-1600

*Repair services are available at these offices.

GENERAL RADIO COMPANY (OVERSEAS)
CH 8034 Zürich 34, Switzerland

GENERAL RADIO GMBH
D8 München 80, West Germany

GENERAL RADIO COMPANY (U.K.) LIMITED
Bourne End Buckinghamshire, England

REPRESENTATIVES IN PRINCIPAL
OVERSEAS COUNTRIES

the  Experimenter

GENERAL RADIO COMPANY
WEST CONCORD, MASSACHUSETTS 01781

Do we have your correct name and address—name, company or organization, department, street or P.O. box, city, state, and zip code? If not, please clip the address label on this issue and return it to us with corrections, or if you prefer, write us; a postcard will do.

PRINTED
IN
U.S.A.